



修訂 REVISIONS	日期 DATE
版次 REV.	記號 DESCRIPTION



1 2 3 4 5 6 7

A

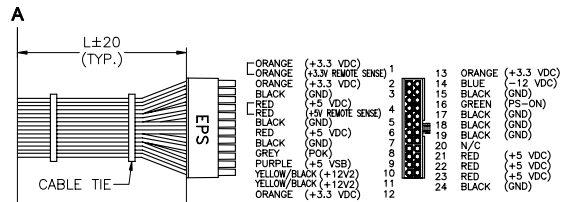
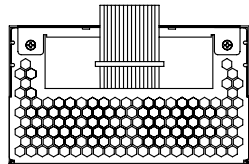

P24

B

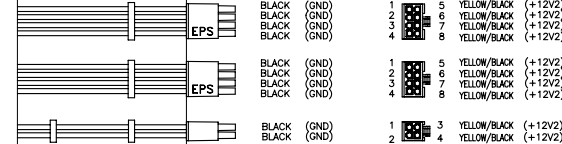
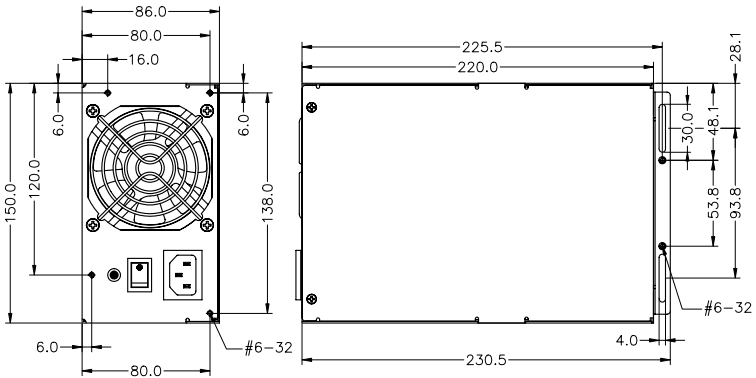

PA-1

PA-2

PB

C

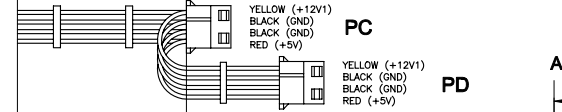
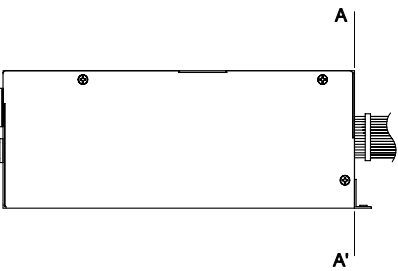

PC

PD

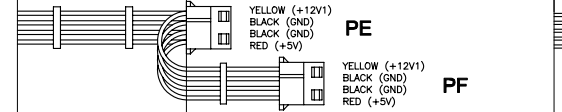

PE

PF

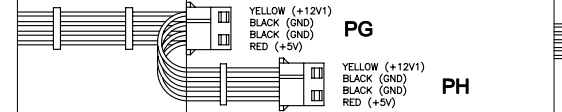

PG

PH

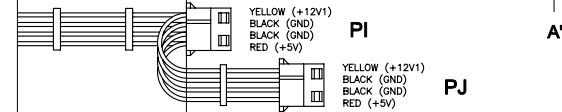

PI

PJ

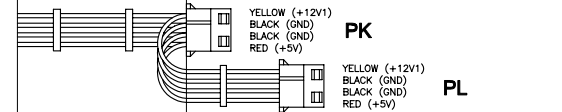

PK

PL

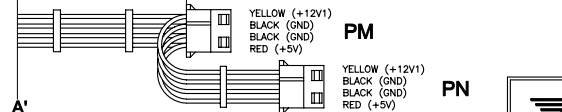

PM

PN

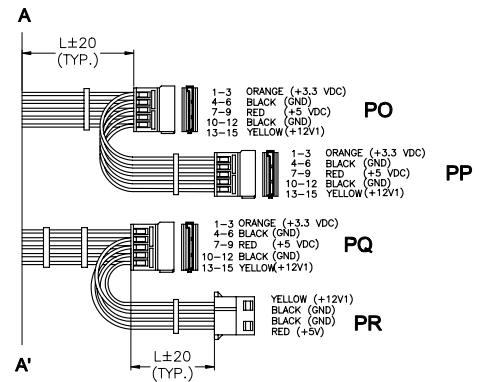

PO

PP

PQ

PR

WIRE LENGTH LIST

HOUSING	LENGTH
P24	460
PA-1	420
PA-2	300
PB	460
PC	400
PD	100
PE	400
PF	100
PG	400
PH	100
PI	400
PJ	100
PK	400
PL	100
PM	400
PN	100
PO	370
PP	230
PQ	600
PR	300

TOLERANCES: ±20
UNIT: mm

Notes:

- (a) All the Length of Output Wires Exclude Housing.
- (b) P24 Connector: MOLEX 39-01-2240 or EQUIV.
Terminal: MOLEX 39-00-0059/79 or EQUIV.
- (c) PA-1,PA-2 Connector: MOLEX 39-01-2080 or EQUIV.
Terminal: MOLEX 39-00-0059/79 or EQUIV.
- (d) PB Connector: MOLEX 39-01-2040 or EQUIV.
Terminal: MOLEX 39-00-0059/79 or EQUIV.
- (e) PC-PN,PR Connector: AMP 1-480424-0 or EQUIV.
Terminal: AMP 61117-4 or EQUIV.
- (f) PO-PQ Connector: MOLEX 675820000 or EQUIV.
Terminal: MOLEX 675810000 or EQUIV.

容許公差: TOLERANCES:	.XXX ±.025 .XX ±.100 .X ±.250
投影法: PROJECTION:	第三角法

材料規格: MATERIAL:	
核准者: APPROVE BY:	黃永欣
日期: DATE:	APR-30-2010
審核者: CHECK BY:	李宗翰
日期: DATE:	APR-30-2010
繪圖者: DRAW BY:	林意斌
日期: DATE:	APR-30-2010

品名: MODEL NO:	PSL-6C00V		
料號: PART NO:	B00PSLOC0V021		
圖號: DRAW NO:	B00PSLOC0V021	檔號: FILE NO:	B00PSLOC0V021
單位: UNITS:	mm	版次: REV. NO:	B1
		規格: SPEC:	A0
		編號: SHEET:	0F

E